

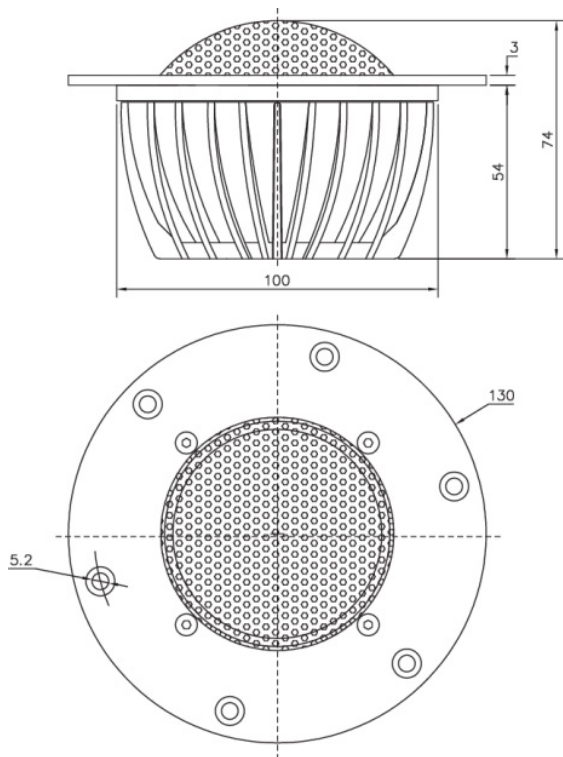

# RS52AN-8 2" Dome Midrange 8 Ohm

RS52AN-8



## PARAMETERS

Impedance	8 ohms
Re	6 ohms
Le	0.13 mH @ 1 kHz
Fs	341 Hz
Qms	3.16
Qes	1.18
Qts	0.86
Mms	1.7g
Cms	0.13 mm/N
Sd	26.4 cm <sup>2</sup>
Vd	2.64 cm <sup>3</sup>
BL	4.26 Tm
Vas	0.13 liters
Xmax	1 mm
VC Diameter	52 mm
SPL	89.4 dB @ 2.83V/1m
RMS Power Handling	60 watts
Usable Frequency Range (Hz)	500 - 14,000 Hz

## FEATURES

- Large damped rear chamber for low resonance point
- 2" Aluminum diaphragm for good clarity and dispersion
- Neodymium magnet minimizes stray magnetic field
- Copper clad motor reduces distortion for transparent sound

## IMPEDANCE/PHASE

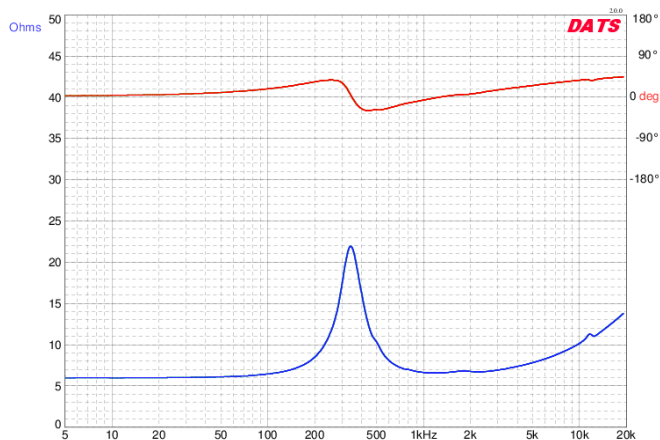

## FREQUENCY RESPONSE

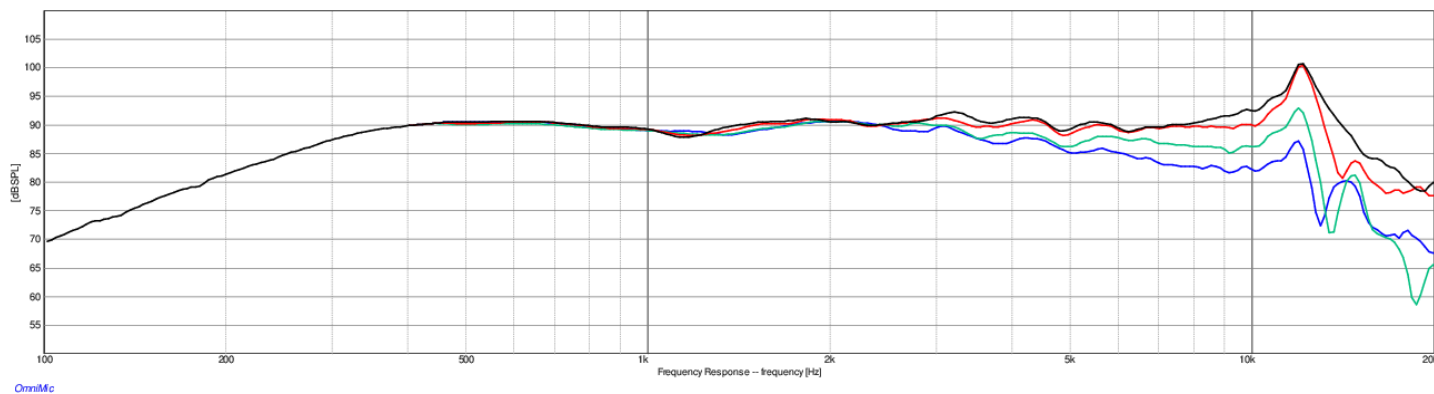

Note: 1/24<sup>th</sup> octave smoothing - nearfield response included in graph below 450 Hz.

Black = 0°  
Red = 15°  
Green = 30°  
Blue = 45°