



C-DSP 6x8

6-IN 8-OUT IN-CAR AUDIO PROCESSOR

User Manual





Revision history

Revision	Description	Date
V0.1	Preliminary version	28 August 2015
V1.0	First release	9 September 2015
V1.1	Revised installation, added subwoofer control	31 January 2017

CONTENTS

- Important Information5
 - System Requirements.....5
 - Disclaimer/Warning.....5
 - Warranty Terms.....6
 - FCC Class B Statement6
 - CE Mark Statement.....6
 - A note on this manual6
- 1 Product Overview7
 - 1.1 Sample usage.....7
 - 1.2 The miniDSP concept.....8
 - 1.3 Plugin feature summary8
- 2 The miniDSP workflow9
- 3 Software installation..... 11
 - 3.1 Windows..... 12
 - 3.2 Mac 13
- 4 Hardware connectivity..... 14
 - 4.1 Analog inputs..... 14
 - 4.2 Digital input 15
 - 4.3 Analog outputs 15
 - 4.4 DC power 16
 - 4.5 Remote 17
 - 4.6 USB 17
- 5 Synchronizing with the processor..... 18
- 6 Configuring the processor..... 19
 - 6.1 Input tab 20
 - 6.2 Routing tab 21
 - 6.3 Output tab 21
 - 6.3.1 Channel strip layout..... 22
 - 6.3.2 Channel label 22
 - 6.3.3 Gain control and level monitoring..... 22
 - 6.3.4 Crossover 23
 - 6.3.5 Parametric EQ..... 25
 - 6.3.6 Time delay 27
 - 6.3.7 Invert and mute 27
 - 6.4 Custom biquad programming..... 28
 - 6.4.1 What’s a “biquad? 28
 - 6.4.2 Using custom biquad programming 28
 - 6.4.3 Biquad design software 30
 - 6.5 Working with configurations 31
 - 6.5.1 Online and offline mode..... 31
 - 6.5.2 Selecting a configuration 31



- 6.5.3 Saving and loading configurations..... 32
- 6.5.4 Loading configurations from microSD card 32
- 6.5.5 Restoring to defaults 33
- 6.6 Keyboard shortcuts 33
- 7 Using the C-DSP 6x8..... 34
 - 7.1 Status indicators 34
 - 7.2 Controls 34
 - 7.3 Subwoofer volume control mode..... 35
 - 7.4 Infrared remote control..... 36
- 8 Additional information..... 37
 - 8.1 Specifications..... 37
 - 8.2 Troubleshooting 38
 - 8.3 Obtaining support..... 39



IMPORTANT INFORMATION

Please read the following information before use. In case of any questions, please contact miniDSP via the support portal at minidsp.desk.com.

SYSTEM REQUIREMENTS

To configure the miniDSP audio processor, you will require a Windows PC or Apple Mac OS X computer with the following minimum specification:

Windows

- PC with 1GHz or higher processor clock speed. Intel® Pentium®/Celeron® family, or AMD K6®/AMD Athlon®/AMD Duron® family, or compatible processor recommended.
- 512 megabytes (MB) of RAM or higher
- Keyboard and mouse or compatible pointing device
- USB 2.0 port
- Microsoft® Windows® Vista® SP1/ XP pro SP2/Win7/Win8.1/Win10
- Microsoft® .NET framework v3.5 or later
- Adobe AIR environment (latest version)
- Adobe Flash player (latest version)

Mac OS X

- Intel-based Mac with 1 GHz or higher processor clock speed
- 512 megabytes (MB) of RAM or higher
- Keyboard and mouse or compatible pointing device
- USB 2.0 port
- Mac OS X 10.8 or higher
- Adobe AIR environment (latest version)
- Adobe Flash player (latest version)

DISCLAIMER/WARNING

miniDSP cannot be held responsible for any damage that may result from the improper use of this product or incorrect configuration of its settings. As with any other product, we recommend that you carefully read this manual and other technical notes to ensure that you fully understand how to operate this product. The miniDSP audio processor is a powerful tool, and misuse or misconfiguration, such as incorrectly set gains or excessive boost, can produce signals that may damage your audio system.

As a general guideline, you should perform the initial configuration of the miniDSP audio processor before enabling audio through any connected output device or amplification. Doing so will help ensure that the software is correctly configured.



Finally, note that the miniDSP audio processor is a very flexible device, and many of the questions we receive at the tech support department are already answered in this user manual and in the online [application notes](#) on the miniDSP.com website. So please take the time to carefully read this user manual and the online technical support. Thanks for your understanding!

WARRANTY TERMS

miniDSP Ltd warrants this product to be free from defects in materials and workmanship for a period of one year from the invoice date. Our warranty does not cover failure of the product due to incorrect connection or installation, improper or undocumented use, unauthorized servicing, modification or alteration of the unit in any way, or any usage outside of that recommended in this manual. If in doubt, contact miniDSP prior to use.

FCC CLASS B STATEMENT

This device complies with Part 15 of the FCC Rules. Operation is subject to the following two conditions:

- This device may not cause harmful interference.
- This device must accept any interference received, including interference that may cause undesired operation.

Warning: This equipment has been tested and found to comply with the limits for a Class B digital device, pursuant to Part 15 of the FCC Rules. These limits are designed to provide reasonable protection. This equipment generates, uses and can radiate radio frequency energy and, if not installed and used in accordance with the instructions, may cause interference to radio communications. However, there is no guarantee that interference will not occur in a particular installation. If this equipment does cause harmful interference to radio or television reception, which can be determined by turning the equipment off and on, the user is encouraged to try to correct the interference by one or more of the following measures:

- Reorient or relocate the receiving antenna.
- Increase the separation between the equipment and receiver.
- Connect the equipment into an outlet on a circuit different from that to which the receiver is connected.
- Consult the dealer or an experienced radio/TV technician for help.

Notice: Shielded interface cable must be used in order to comply with emission limits.

Notice: Changes or modification not expressly approved by the party responsible for compliance could void the user's authority to operate the equipment.

CE MARK STATEMENT

The C-DSP 6x8 has passed the test performed according to European Standard EN 55022 Class B.

A NOTE ON THIS MANUAL

This User Manual is designed for reading in both print and on the computer. If printing the manual, please print double-sided. The embedded page size is 8 ½" x 11". Printing on A4 paper will result in a slightly reduced size.

1 PRODUCT OVERVIEW

Thank you for choosing the miniDSP C-DSP 6x8 audio processor. The miniDSP C-DSP 6x8 is a powerful and flexible digital audio processor specifically designed for in-car audio systems. It features:

- Isolated power supply designed for in-car use
- Stereo digital S/PDIF input (RCA connector)
- Four analog input channels, by terminal block (8 VRMS) or RCA connector (4 VRMS)
- Eight analog output channels (RCA)
- Volume control by external wired remote or infrared remote
- Advanced audio tuning on every channel:
 - Parametric EQ (peaking/high shelf/low shelf)
 - Butterworth and Linkwitz-Riley crossovers up to 48 dB/octave
 - Individual time delay and level adjustment
 - Advanced biquad programming for an unlimited range of filters and crossover types
- Matrix mixer for flexible channel assignment and configuration
- Real-time configuration of all processing parameters
- Four on-board presets, selectable by external wired remote or infrared remote

1.1 SAMPLE USAGE

The C-DSP 6x8 typically connects to a head unit with four output channels, and directly drives power amplifiers for multiple loudspeakers or drivers. Because of its flexible internal routing, the C-DSP 6x8 can be used in a variety of situations involving a mix of passive speakers, active speakers, and subwoofers.

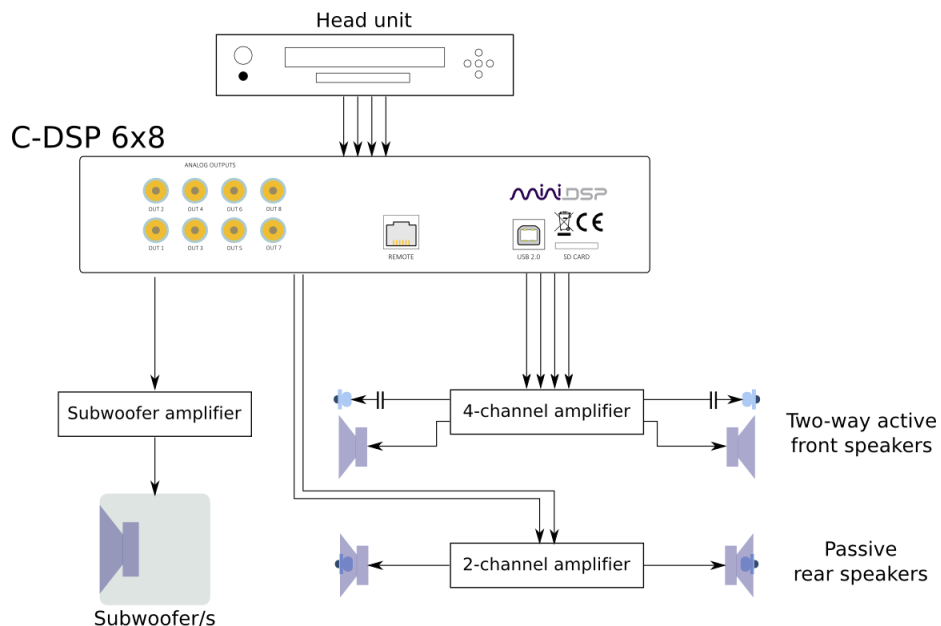

1.2 THE MINIDSP CONCEPT

The miniDSP concept is “one hardware unit + one software plugin = audio processing solution.” This concept leverages the inherent flexibility of DSP (digital signal processing) to deliver a range of flexible but cost-effective solutions.

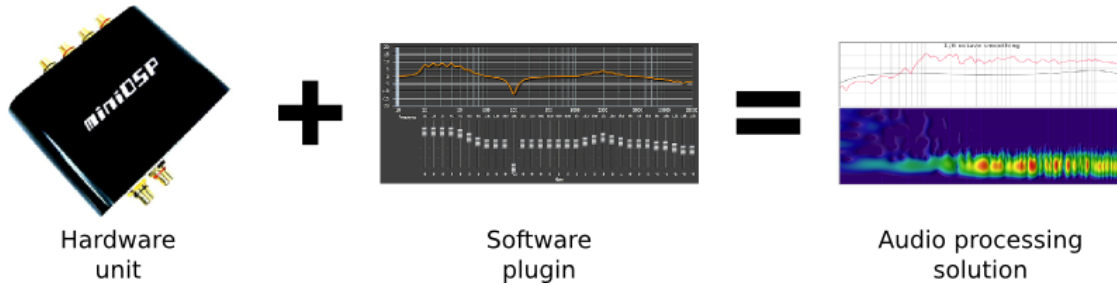

Hardware unit

In this case, the hardware unit is the miniDSP C-DSP 6x8.

Software plugin

The software plugin is installed on your PC or Mac, and determines the processing that the DSP will perform. It provides a friendly user interface, and downloads instructions into the miniDSP hardware unit that tell it how to process the audio signal.

Other platforms

miniDSP makes many other boxed and kit hardware units with analog, stereo digital, and multichannel digital (HDMI) connections. Some units feature inbuilt Class D amplification. See the [full range of miniDSP products](#).

1.3 PLUGIN FEATURE SUMMARY

The table below summarizes the key features of the **C-DSP 6x8** plugin:

	C-DSP 6x8 plugin
Number of digital input channels ¹	2
Number of analog input channels	4
Number of analog output channels	8
Digital input sample rate	44.1 to 192 kHz
Internal sample rate	48 kHz
Number of PEQ bands per block	6
Crossover order	6 to 48 dB/octave
Compressor block	No
Maximum per-channel time delay	15 ms

¹1 two channels = single stereo digital signal

2 THE MINIDSP WORKFLOW

We strongly recommend taking a methodical approach to your new miniDSP audio processor. Remember that the audio processor is a powerful tool, and incorrect settings can potentially cause damage to your system. Please follow the steps below carefully.

1. Download and install the plugin

When your order ships, your ordered plugin will be available from the [User Downloads](#) section of the miniDSP website. Download and install your plugin, as described in [Software installation](#) on page 11.

2. Familiarize yourself with the plugin

Before connecting your computer to the processor, it's worth familiarizing yourself with the user interface presented by the plugin. Click on and explore each of the tabs (**Input**, **Routing**, and **Output**). For more information, see [Configuring the processor](#) starting on page 19.

At this time, the plugin is still in *offline* mode, so any changes you make will not be downloaded into the miniDSP hardware. Since we will reset all of the processing parameters in the next step, you can feel free to experiment at this point.

3. Reset all parameters

From the **Restore** menu, select the **Factory Default** option. This will reset all processing parameters back to the defaults and ensure that you have a "clean slate" for the next step.

4. Perform initial configuration

Use the plugin to set up an initial audio processing configuration as intended for your application. For example, typical things that can be done at this point are to:

- Set the labels of input and output channels
- Mute unused input and output channels
- Set crossover frequencies and slopes
- Set up any essential equalization

5. Save configuration

At this point, save your initial configuration to a file. A *configuration* is the set of all audio processing parameters. You should save your configuration to a file on a regular basis, to ensure that you do not lose your work if you inadvertently restore the miniDSP to default settings. For more information on configurations, see [Working with configurations](#) on page 31.

6. Make audio connections

With the initial configuration done and now that you are familiar with the various controls, it's time to connect the miniDSP C-DSP 6x8 into your system. *Ensure that all power is turned off when making audio connections.* See [Hardware connectivity](#) on page 14.

7. Go into online mode

Apply power to the processor. (See [DC power](#) on page 16 for more information. Leave other equipment turned off at this stage.) Connect the USB cable to your computer, click on the **Connect** button, and select the **Synchronize** option. If all goes well, you are now in *online mode*, and any changes that you now make in the plugin user interface will be immediately sent to the processor.



Before proceeding, click on each Configuration preset button (Config 1, 2, etc.) to ensure that all presets have been synchronized and/or set to defaults.

For more information, see [Synchronizing with the processor](#) on page 18.

8. Initial audio check

Power on your connected equipment, first on the input side (e.g. head unit), then on the output side (e.g. power amps). Turn the volume on your C-DSP 6x8 down low (view the Master Volume display in the plugin while turning the knob counter-clockwise) and start playing music or a pink noise test signal. Gradually increase the volume until you hear audio quietly coming from the speakers. Verify that the plugin is performing the intended function. (For example, if implementing a two-way crossover, confirm that the tweeter is playing high frequencies, and that the woofer is playing low frequencies.)

9. Fine-tune your configuration

With your initial setup running, you can now proceed to fine-tune and optimize your system. You will need to perform acoustic measurements and use the configuration screens to adjust processing parameters.



Be sure to save your configuration on a regular basis while working on fine-tuning it. Configurations can be saved to different files, in order to archive different versions, or to enable auditioning of alternative configurations.

10. Continue to operate offline

With your miniDSP processor configured, you can continue to operate in *offline mode*—that is, without the computer connected. To do so, simply disconnect the USB cable. The processor “remembers” the configuration last set, and will continue to operate without the computer.

Note: while in offline mode, the configuration can still be modified in the plugin interface. These changes will not be downloaded to the processor until it is synchronized again. See [Working with configurations](#) on page 31.

3 SOFTWARE INSTALLATION

If you purchased your product directly from miniDSP, your software will be available from the [User Downloads](#) section of the miniDSP website when your order ships. You will need to be logged into the website with the account you created when purchasing to access the download.

If you purchased your product from a miniDSP dealer, you will receive a coupon together with the product. Redeem this coupon and select the Plugin Group “CDSP 6x8” at the link below:

- <https://www.minidsp.com/support/redeem-coupon>

The User Downloads link is visible from the dropdown menu at the top right of the website page:

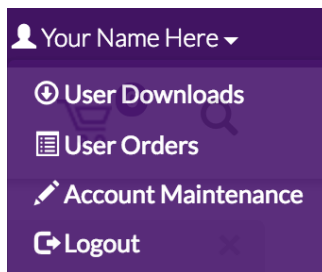

Navigate to the **C-DSP plug-ins** section and download the zip file under the heading C-DSP 6x8 plugin. Unzip the downloaded file (on Windows, right-click and select “Extract All...”; on Mac, double-click).

Note: the Adobe Air framework may need a network connection the first time the plugin is used. If the plugin does not start properly, see [Troubleshooting](#).

3.1 WINDOWS

The miniDSP software requires that a number of other frameworks be installed for it to work. For Windows 7 and later, these packages should be installed automatically. For earlier versions of Windows, please download and install the following frameworks before attempting to install any miniDSP software. You can also manually install these if you receive an error message that required software is missing.

- [Microsoft .NET framework](#) (version 3.5 or later)
- Latest version of [Adobe Air](#)
- Microsoft Visual C++ 2010 Redistributable Package: for [x86](#) (32-bit operating system) or [x64](#) (64-bit operating system).

To install the plugin:

1. Navigate to the **Windows** folder of the software download.
2. Double-click on the **C-DSP-6x8.exe** installer program to run it. We recommend that you accept the default installation settings.
3. The plugin will start automatically if you accepted the default installation settings. To make it quicker to run in future, right-click on its icon in the taskbar and select “Pin to taskbar.”

Note: the first time you run the plugin, you may see a warning from Windows Firewall as shown below. If so, ensure that “Private networks...” is checked and “Public networks...” is not checked. Then click on “Allow access.”

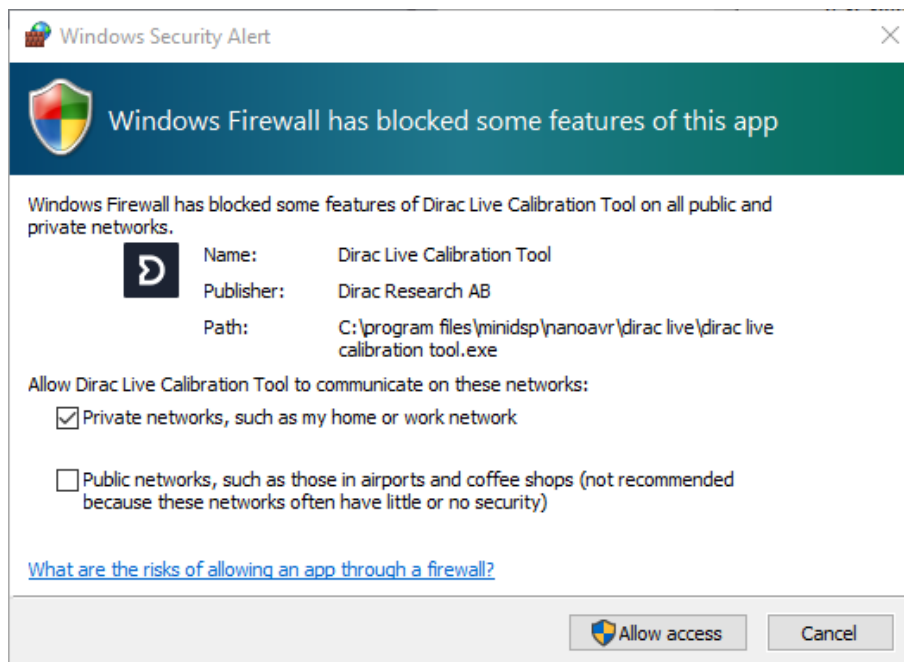

3.2 MAC

To install the plugin:

1. Navigate to the **Mac** folder of the software download.
2. The installer program is named **C-DSP-6x8.pkg**. To run it, double-click on it, or right-click and open as described above. We recommend that you accept the default installation settings.
3. To run the plugin, locate **C-DSP-6x8.app** in the Applications -> miniDSP folder and double-click on it. To make it easier to run in future, right-click on its dock icon and select Options -> Keep in Dock.

Note: If double-clicking on an installer brings up a message that the installer cannot run, use this alternate method (note that the name of the plugin will be **C-DSP-6x8.pkg**, not **MiniDSP_Plugin.pkg** as shown in the screenshots):

1. Right-click on the installer (or click while holding the Control key).
2. On the menu that pops up, move the mouse over the “Open With” item and then click on “Installer (default).”

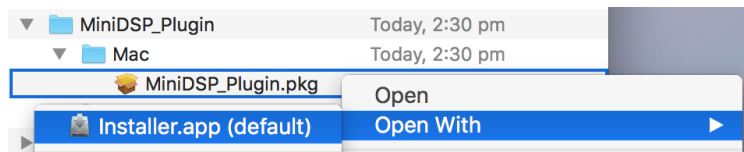

3. The following window will appear. Click on “Open.”



4 HARDWARE CONNECTIVITY

Connections to the C-DSP 6x8 are made on the front and rear panels.

4.1 ANALOG INPUTS

There are four analog output channels. Unbalanced connections can be made directly to the RCA jacks on the front panel. Be sure to take careful note of the channel numbering shown in this diagram and on the front panel. These inputs accept a maximum input voltage of 4 VRMS.

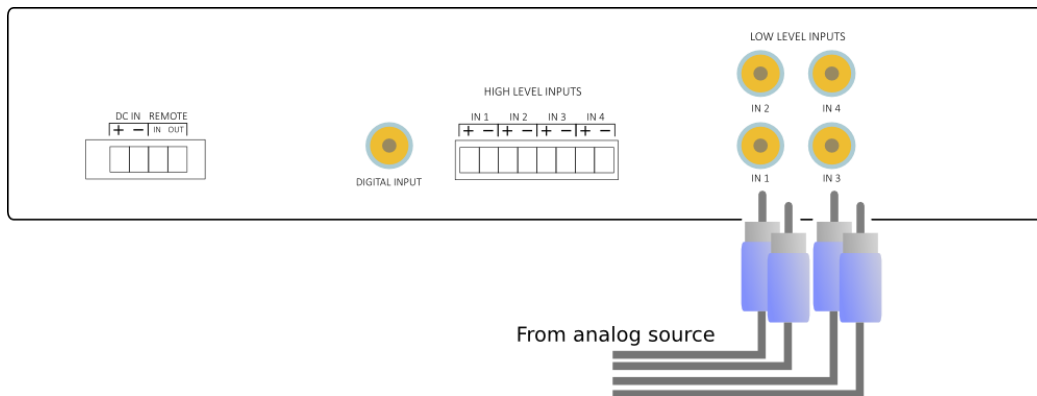

Alternately, connections can be made by connecting bare wire ends to the push-in terminal block. Remove the terminal, and connect individual positive and negative wires to each set of screw terminals. After all connections are secure, firmly re-insert the terminal blocks. These inputs accept up to 8 VRMS.

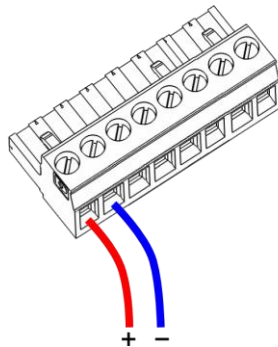

4.2 DIGITAL INPUT

Connect a digital source to the S/PDIF coax (RCA) connector on the front panel.

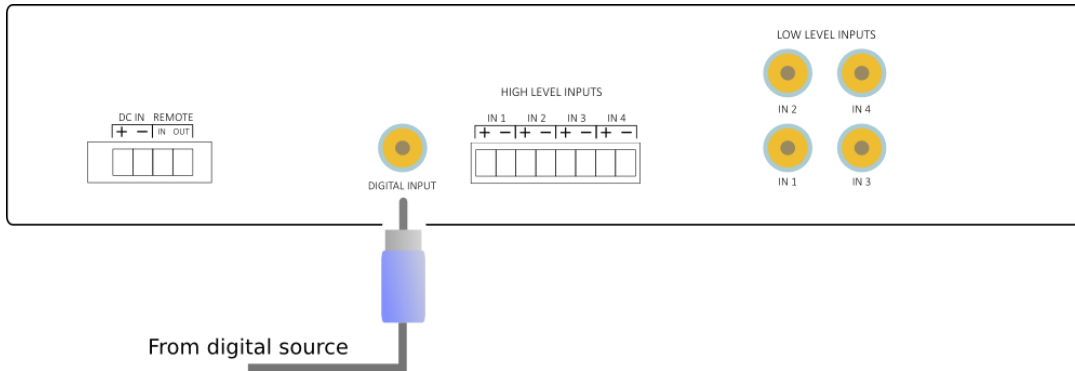

Note: the digital input accepts only a stereo PCM digital signal. It does not accept encoded or multichannel digital audio.

4.3 ANALOG OUTPUTS

There are eight analog output channels. Unbalanced connections are made from the RCA jacks on the rear panel to the power amplifiers. Be sure to take careful note of the channel numbering shown in this diagram and on the rear panel.

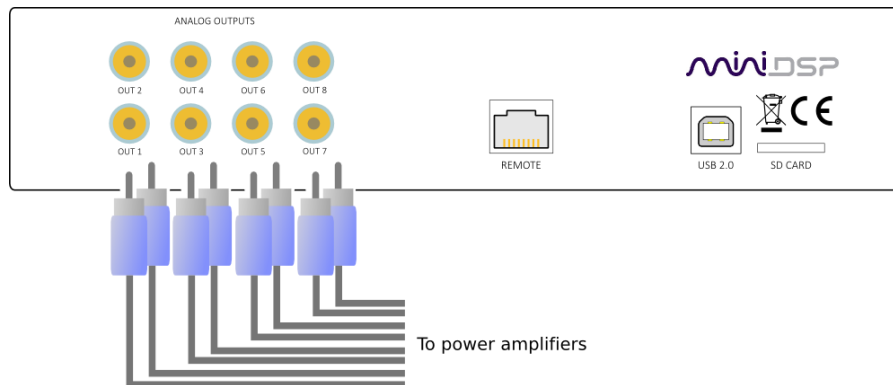

4.4 DC POWER

The C-DSP 6x8 incorporates an isolated DC power convertor and is designed for direct connection to the vehicle's power supply (nominally 12V). Power is connected via the four-way terminal block:

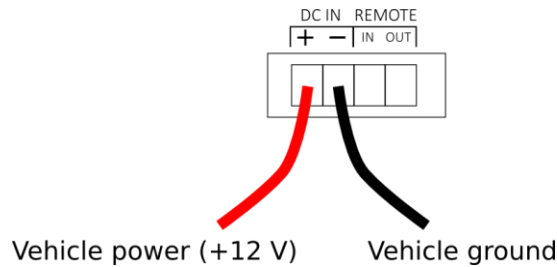

The terminal block also provides two pins for remotely switching power on and off. To enable the remote enable, a jumper inside the unit needs to be moved.

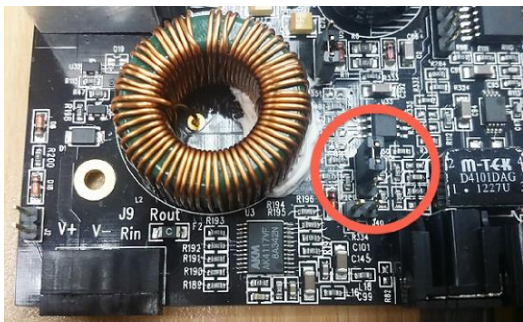

REMOTE disabled



REMOTE enabled

REMOTE IN

This input will turn the C-DSP 6x8 on and off. This is a useful feature for battery-operated systems, to avoid draining the battery. A simple example is shown at right. The behavior is as follows:

- 0V < REM IN < 4V: C-DSP 6x8 is OFF
- 4V < REM IN < 12V: C-DSP 6x8 is ON

REMOTE OUT

This output supplies a delayed version of REM IN, to trigger external equipment after a 2-second delay.

Toggle switch (SPST) to turn power on/off

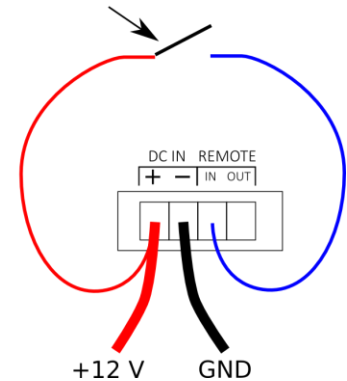

4.5 REMOTE

The wire remote can be positioned anywhere in the vehicle and is connected via the supplied cable. The RJ11 plugs on each end simply plug into the base of the remote and into the rear panel of the C-DSP 6x8. The wired remote also contains the receiver for infrared remote control.

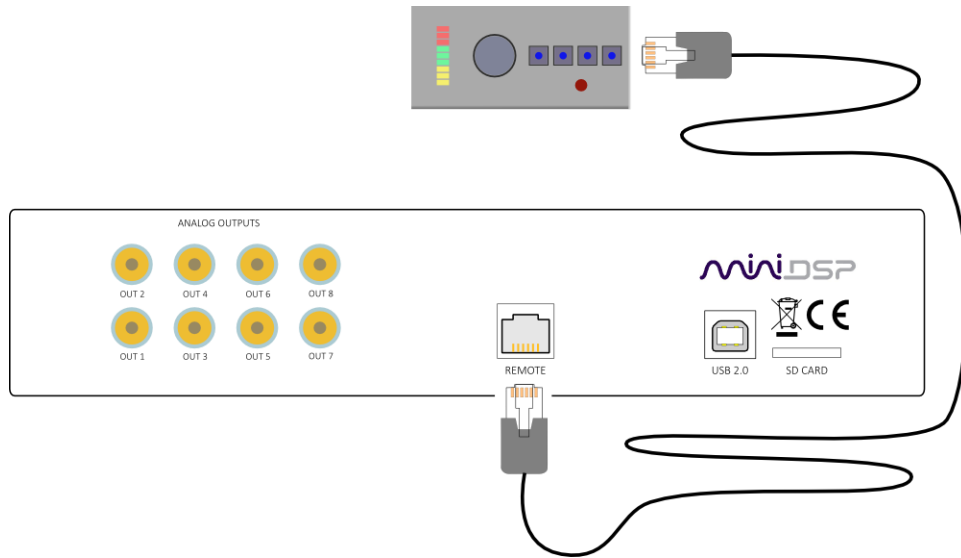

4.6 USB

To configure the processor, connect its USB port to a USB 2.0 port on your computer using the supplied cable. Note that USB is used only for configuration—audio data cannot be streamed to the processor over USB.

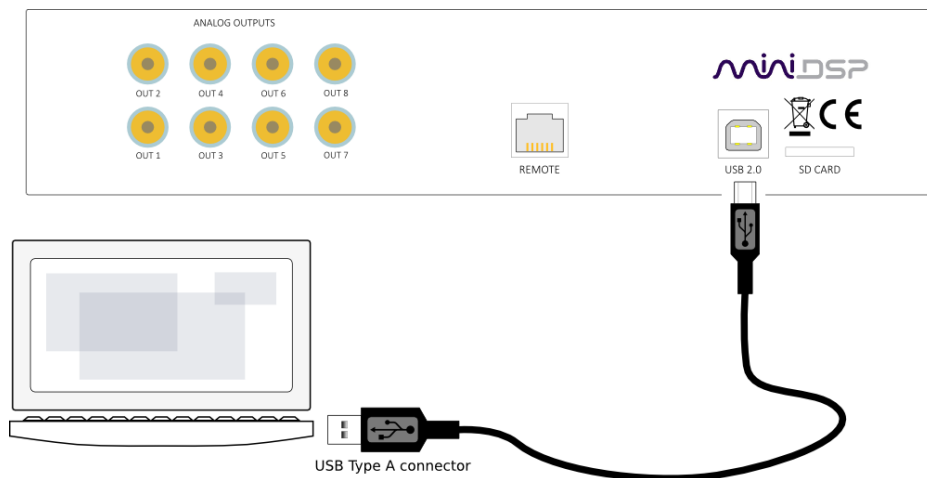

5 SYNCHRONIZING WITH THE PROCESSOR

Communication with the C-DSP takes place over a USB connection. Note that USB is used for control purposes only. Audio data cannot be streamed to the processor over USB.

Ensure that the computer is connected to the processor by a USB 2.0 port. Then click on the **Connect** button:



The first time you connect, or if you have made any changes to any data in the user interface, the following dialog box will appear:

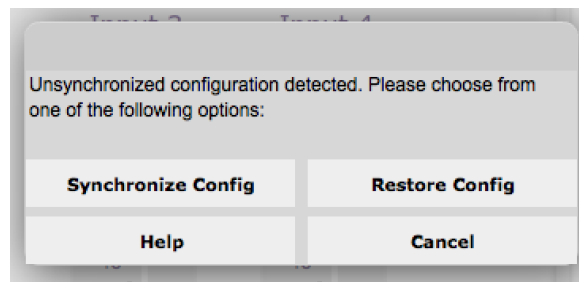

The options are:

Synchronize Config

Download the currently selected configuration into the corresponding configuration preset of the processor. After downloading the configuration data, the plugin is in *online* mode and any changes to processing parameters will be downloaded immediately in real time. That is, the user interface is now “live.”

Synchronize and Upgrade

This is similar to Synchronize Config, but also upgrades the internal data of the processor. This option may appear after downloading and installing an updated version of the plugin.

Restore Config

Restore the data in the currently selected configuration to the factory defaults. When using this option, any connected output equipment should be muted or powered off until you have set the configuration to a working state. Note that the configuration data will be lost, so ensure that you have saved the configuration to a file prior to using this option.

Cancel

This option cancels the attempt to connect to the processor. The plugin will remain in offline mode.

6 CONFIGURING THE PROCESSOR

The C-DSP 6x8 processor is configured with the **C-DSP 6x8** plugin / user interface program. Once fully configured, the computer is no longer required, as source and preset selection can be done with the wired remote or an infrared remote control—see [Using the C-DSP 6x8](#). If desired, however, the plugin can remain connected during use for real-time (“live”) control of all audio processing.

This screenshot shows the **C-DSP 6x8** plugin with the key areas highlighted:

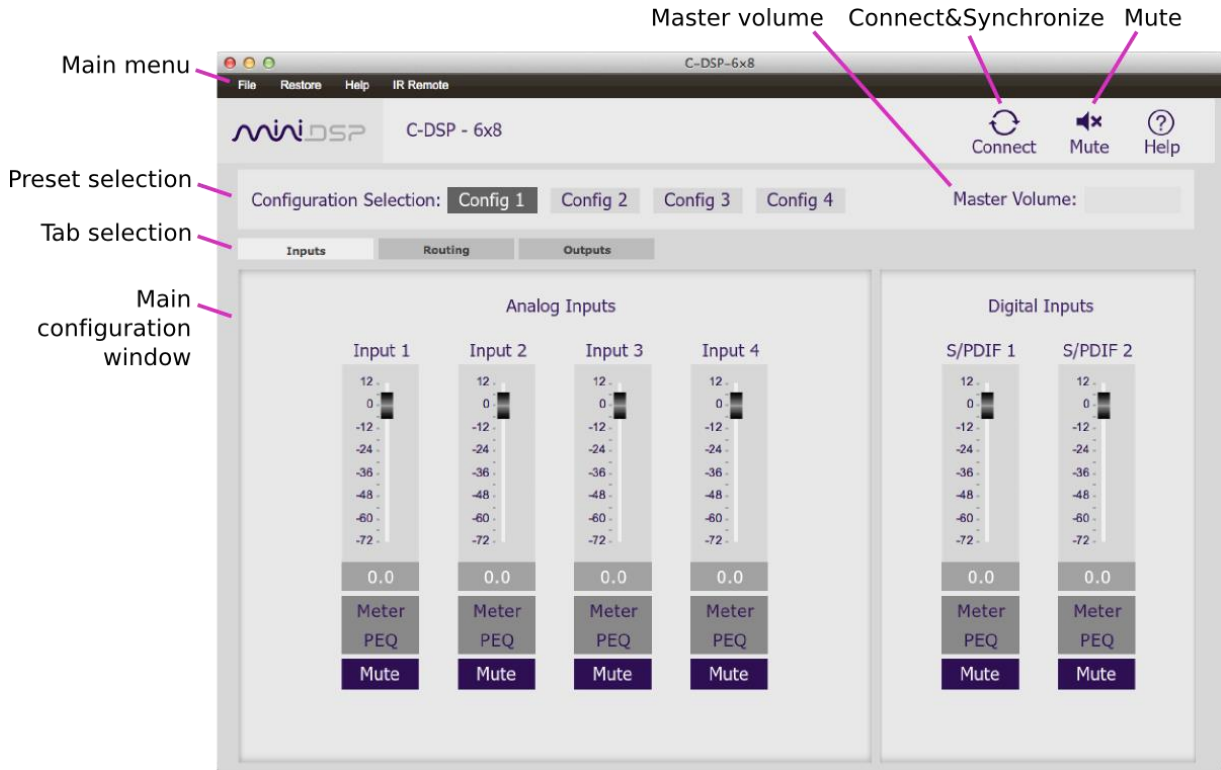

 During *initial* configuration of the processor, it is strongly recommended that any connected amplification be muted or powered off.

The **Mute** button disables all audio output:



The Master volume display shows the current volume setting:

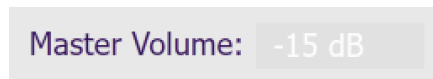

6.1 INPUT TAB

The **Input** tab displays a row of input channel control strips:



Channel label

Each input channel has a customizable label, which is shown at the top of the channel strip. This label also appears on the **Routing** tab. To change the label, click on it, type a new label (up to eight characters), and press the Return key.

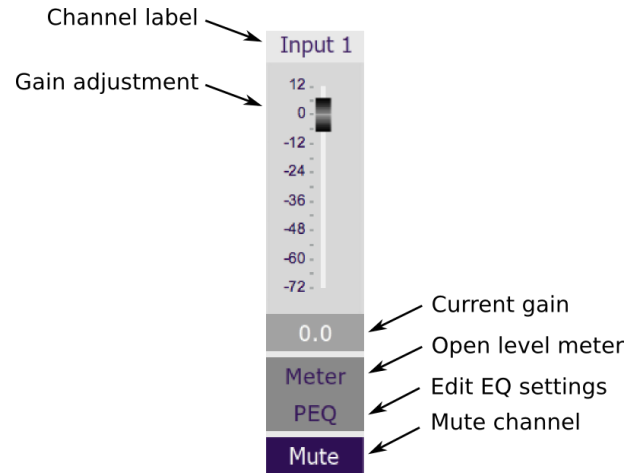

Gain adjustment

The gain of each channel can be adjusted by moving the Gain Adjustment slider, or by typing the desired gain into the Current Gain text box. The maximum gain setting is 12 dB, and the minimum gain setting is -72 dB. (0 dB, the default, is unity gain or no change in level.)

Meter

Click this button to bring up an overlay that displays the current signal level in real time. (The plugin must be in online mode to display signal levels.)

PEQ

Click on this button to open the parametric EQ settings window for that channel. There are ten parametric EQ filters on each input channel. For more details, see [Parametric EQ](#) on page 25.

Mute

Press this button to mute that input channel. A visual indicator shows that the channel is muted.



6.2 ROUTING TAB

The **Routing** tab displays the matrix mixer, which sets up the routing from input channels to output channels. The input channels are labeled along the left, and the output channels along the top. To make the routing matrix easier to view, the labels of the input and output channels can be changed in the **Input** and **Output** tabs.

Each input-output channel assignment is turned on and off by clicking the button corresponding to the two channels. This is the default routing:

	Output 1	Output 2	Output 3	Output 4	Output 5	Output 6	Output 7	Output 8
Input 1	On	On	Off	Off	Off	Off	Off	Off
Input 2	Off	Off	On	On	Off	Off	Off	Off
Input 3	Off	Off	Off	Off	On	On	Off	Off
Input 4	Off	Off	Off	Off	Off	Off	On	On
S/PDIF 1	Off	Off	Off	Off	Off	Off	Off	Off
S/PDIF 2	Off	Off	Off	Off	Off	Off	Off	Off

Each output channel can have more than one input channel routed to it. In that case, those input channels are mixed together. This can be used, for example, to mix left and right inputs for a subwoofer feed.

6.3 OUTPUT TAB

The **Output** tab displays a row of output channel control strips. All channels are identical.

The image shows eight identical control strips for Output 1 through Output 8. Each strip contains a vertical volume fader with a scale from -72 to 12, a gain knob set to 0.0, and three buttons: Meter, PEQ, Xover; Invert, Mute. The Output 4 strip is highlighted with a blue border and a small blue triangle pointing to the gain knob.

6.3.1 Channel strip layout

Each output channel has a complete "strip" of controls.

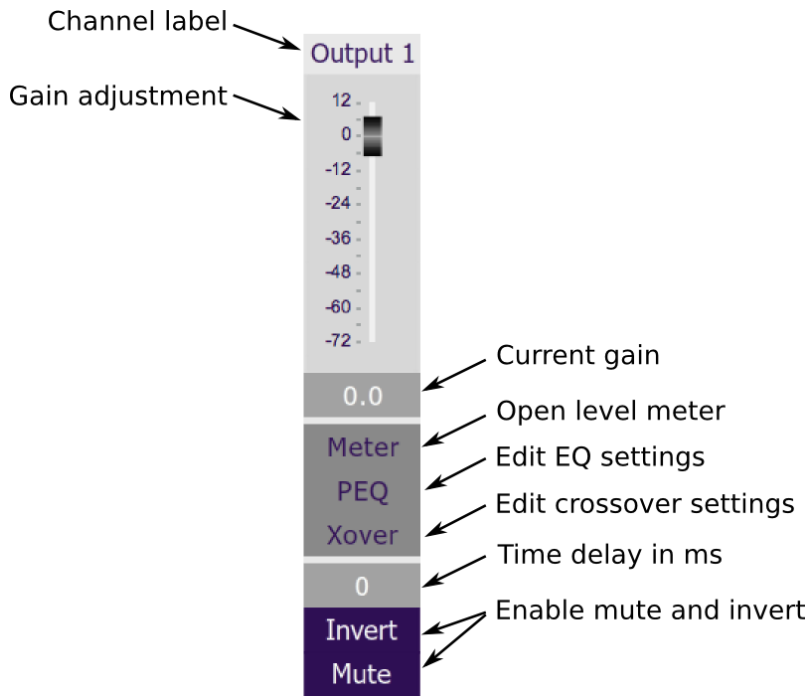

6.3.2 Channel label

Each output channel has a customizable label, which is shown at the top of the channel strip. This label also appears on the **Routing** tab. To change the label, click on it, type a new label (up to eight characters), and press the Return key.

6.3.3 Gain control and level monitoring

Gain adjustment

The gain of each channel can be adjusted by moving the Gain Adjustment slider, or by typing the desired gain into the Current Gain text box. The maximum gain setting is 12 dB, and the minimum gain setting is -72 dB. (0 dB, the default, is unity gain or no change in level.)

Meter

Click this button to bring up an overlay that displays the current signal level in real time. (The plugin must be in online mode to display signal levels.)

The level meters are useful in many situations. For example, when adding filters with boost, monitor the level meters with typical signals and maximum levels to ensure that there is no clipping. The meters can also be used during normal operation to monitor for or to help locate level or gain structure problems.

6.3.4 Crossover

Each output channel has independent high pass and low pass filters. Click on the **Xover** button to open the crossover settings window:

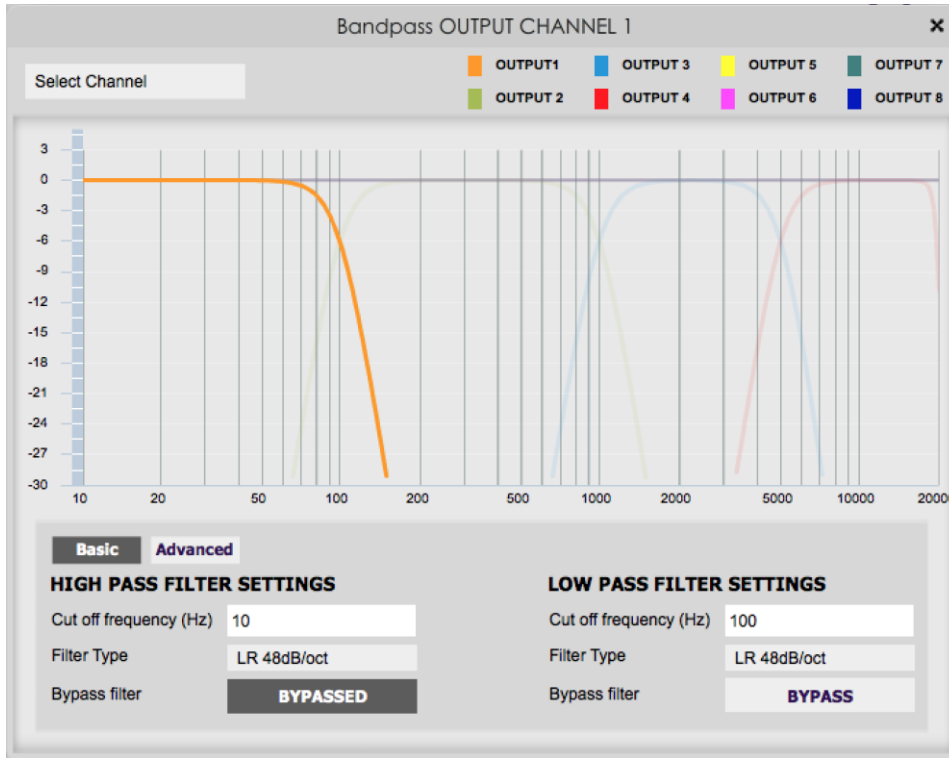

Crossovers “split” the frequency band to send to different drivers. In a two-way loudspeaker, for example, a *low pass* filter is used to remove high frequencies from the signal sent to the woofer, and a *high pass* filter is used to remove low frequencies from the signal sent to the tweeter. In a three-way speaker, the midrange driver will use both the high pass and low pass filters. Crossover filters can also be used to limit low frequency content delivered to a speaker or subwoofer, to help protect it from over-excursion.

Unlike conventional analog crossovers, the flexibility of DSP allows a completely arbitrary mix of different filter slopes and types. Filters can be set at any frequency, or disabled completely. This allows maximum flexibility in matching your crossover to the acoustic characteristics of the loudspeaker drivers.

Hovering the mouse over the curve brings up an overlay showing the frequency and the attenuation at that frequency.

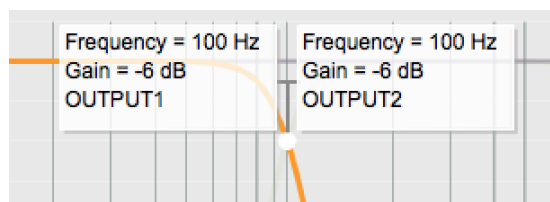

Basic/Advanced

By default, the crossover is in basic mode, and shows the controls described below. Advanced mode enables custom biquad programming for almost infinite flexibility in crossover filter implementation. This is described in [Custom biquad programming](#) on page 28.

Cutoff Frequency

Sets the nominal cutoff frequency of the crossover. In actual fact, the crossover has a more or less gradual transition from “full on” to “full off,” as determined by the filter slope.

Filter type

Selects the type and slope of the filter. The steeper the slope, the more quickly frequencies above or below the cutoff frequency are attenuated. There are three types of filter:

Butterworth (BW)

Available in 6, 12, 18, 24, 30, 36, 42, and 48 dB/octave, Butterworth crossover filters are 3 dB down at the cutoff frequency.

Linkwitz-Riley (LR)

Available in 12, 24, 36, and 48 dB/octave, Linkwitz-Riley crossover filters are 6 dB down at the cutoff frequency.

Bessel

Available in 12 dB/octave only, a Bessel filter gives a more gradual roll-off through the crossover region.

Bypass

Clicking on the **Bypass** button disables or enables that high pass or low pass filter. The filter is bypassed when the button is greyed out, as shown at right.



Each channel can be linked to one other channel. When a channel is linked to another, the crossover settings of that channel are mirrored to the other. Typically, the corresponding drivers on the left and right channels are linked: left and right tweeter, left and right woofer, and so on. To link a channel, select the other channel from the drop-down menu at the top left of the **Xover** screen, and click the **Link** checkbox.

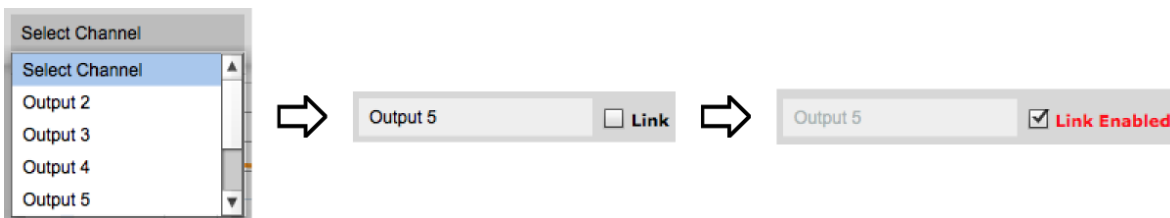

6.3.5 Parametric EQ

Parametric equalization (PEQ) is a flexible type of equalization filter. It can be used to correct for errors in loudspeaker output, to compensate for acoustic room effects, and to tailor the overall system response for best sound. Click on the PEQ button to open the parametric equalizer settings window:

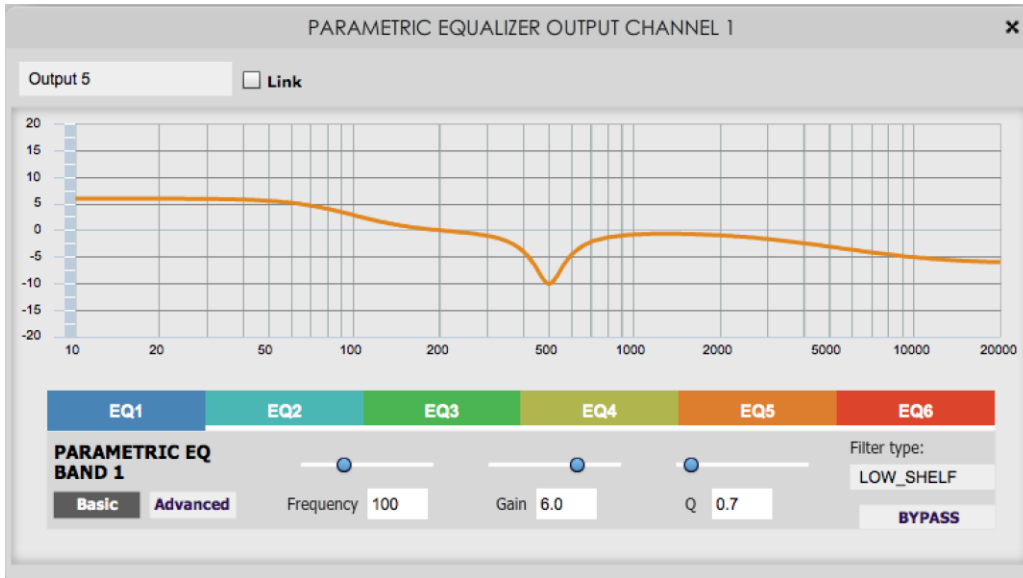

There are six parametric EQ filters on each input and output channel. The window displays a frequency response graph showing the combined response of all enabled parametric filters on that channel. For example, the screenshot above shows a response curve created with a low-shelf boost filter at 100 Hz, a dip at 500 Hz, and a high-shelf cut filter at 5000 Hz.

Hovering the mouse over the curve brings up an overlay showing the frequency and the gain at that frequency.

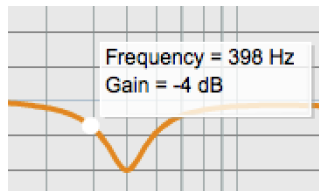

Each channel can be linked to one other channel. When a channel is linked to another, the PEQ settings of that channel are mirrored to the other. Typically, the corresponding drivers on the left and right channels are linked: left and right tweeter, left and right woofer, and so on. To link a channel, select the other channel from the drop-down menu at the top left of the **PEQ** screen, and click the **Link** checkbox.

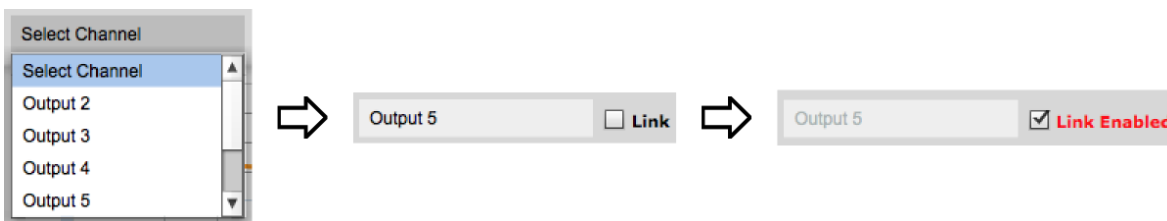

EQ band selection

Click on the radio buttons **EQ1**, **EQ2**, etc. to display the parameters for that filter.

Basic/Advanced

By default, each filter is in basic mode, and shows the controls described below. Advanced mode enables custom biquad programming for almost infinite flexibility in filter implementation. This is described in [Custom biquad programming](#) on page 28.

Filter type

Selects the type of filter:

- PEAK** Create a dip or a peak in the frequency response.
- LOW_SHELF** Reduce or increase part of the frequency spectrum *below* a given frequency.
- HIGH_SHELF** Reduce or increase part of the frequency spectrum *above* a given frequency.
- SUB_EQ** Create a dip or a peak in the frequency response at low frequencies (10 to 50 Hz). This filter type is similar to PEAK but gives more accurate results for low frequencies. Note that activating any SUB_EQ filter reduces the number of available filters on that channel from six to five.

Frequency

For the PEAK and SUB_EQ filter types, this is the center frequency of the peak or dip. For the HIGH_SHELF and LOW_SHELF filter types, this is the frequency at which the gain is half of the set value.

Gain

For the PEAK and SUB_EQ filter types, this is the gain in dB at the center frequency. For the HIGH_SHELF and LOW_SHELF filter types, this is the gain in dB reached at high or low frequencies respectively. A filter has no effect if its gain is set to 0 dB. Gain can be adjusted in increments of 0.1 dB up to +/- 16 dB.

Q

Q controls the “sharpness” of the filter. For the PEAK and SUB_EQ filter types, lower Q gives a broader peak or dip, while higher Q gives a narrower peak or dip. For the HIGH_SHELF and LOW_SHELF filter types, Q controls how quickly the filter transitions from no gain to maximum gain.

Bypass

The **Bypass** button enables or disables a filter. The filter is bypassed if the button is greyed out, as shown at right. (Note that all other filters are still operational unless individually bypassed.) A filter will also have no effect if its gain is set to 0.0.



6.3.6 Time delay

A delay of up to 15 ms can be applied to each output channel. To set the delay, click in the delay entry box for a channel. The delay value can be entered numerically, and the up and down arrows can be used to change the delay in small (0.02 ms) increments.

The time delay corresponds to a distance. This distance is shown in cm when the cursor is hovered over the time delay box. The maximum time delay of 15 ms corresponds to a distance of approximately 5.2 meters (about 18 feet).

Time delay can be calculated from distance using one of the following formulae:

$$(\text{Time delay in ms}) = (\text{Distance in cm}) / 34.4$$

Or:

$$(\text{Time delay in ms}) = (\text{Distance in inches}) / 13.54$$

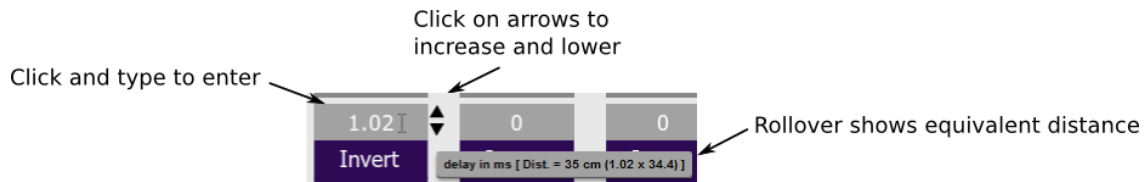

6.3.7 Invert and mute

Each channel can be inverted in polarity, and individually muted. When either of these options is selected, the display changes color and the label of the button reflects the current state.

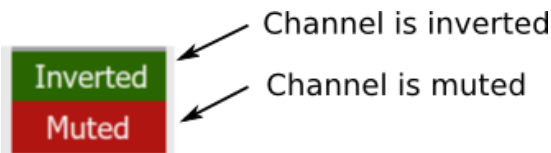

6.4 CUSTOM BIQUAD PROGRAMMING

Custom biquad programming is available in the PEQ and Crossover blocks. Its purpose is to allow you to directly provide the low-level parameters aka *biquad coefficients* that control the digital filters of the processor, thus providing an almost infinite degree of flexibility.

For example, you can create hybrid crossovers with staggered cutoff frequencies, create parametric EQ filters beyond those provided in the easy-to-use “basic” interface, implement a Linkwitz transform, or mix crossover and EQ biquads in the same block.

6.4.1 What’s a “biquad”?

A biquad is the basic unit of processing that is used to create digital filters. It can be described either with an equation or with a signal flow diagram, as shown here:

$$H(z) = \frac{b_0 + b_1 z^{-1} + b_2 z^{-2}}{1 + a_1 z^{-1} + a_2 z^{-2}}$$

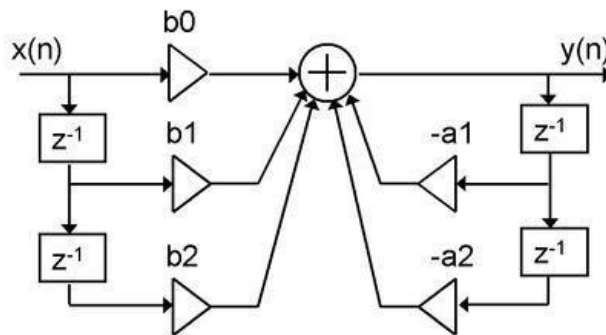

A single biquad like this can perform a great many functions, including all of the functions of a single parametric EQ filter, one 6 or 12 dB/octave high pass or low pass filter, and more. Biquads are combined in series (cascaded) to create more complex filters. The function that each biquad performs is determined by just five numbers: a_1 , a_2 , a_0 , b_1 , and b_2 . These numbers are called the *coefficients*.

6.4.2 Using custom biquad programming

Each crossover block and PEQ filter has a selector that switches it to advanced mode:



In advanced mode, the biquad coefficients can be pasted directly into the user interface. These coefficients must be calculated using a design program – see [Biquad design software](#) below for suggestions.

Parametric EQ advanced mode

In the parametric EQ blocks, advanced mode allows each individual filter to be specified by its biquad coefficients. After pasting in the coefficients, click on the **Process** button for them to take effect.

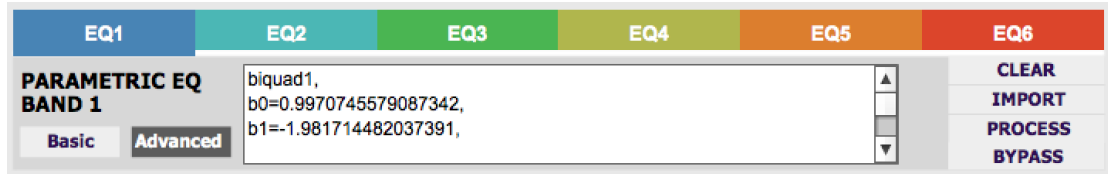

Parametric EQ file import (REW integration)

Multiple biquads in the parametric EQ block can be set at once by importing a coefficient file. (Click on the **IMPORT** button.) This file can be generated by Room EQ Wizard (REW) or by other programs. The design program must be set for a **48 kHz** sample rate if using the **C-DSP 6x8** plugin. The number of filters is limited to a maximum of six.

This example illustrates the correct file format:

```
biquad1,
b0=0.998191200483864,
b1=-1.9950521500467384,
b2=0.996920046761057,
a1=1.9950521500467384,
a2=-0.9951112472449212,
biquad2,
b0=0.999640139948623,
b1=-1.9981670485581222,
b2=0.9985489719847982,
a1=1.9981670485581222,
a2=-0.9981891119334211,
biquad3,
...
biquad4,
...
biquad5,
b0=1.0010192374642126,
b1=-1.9950555192569264,
b2=0.9940580112181501,
a1=1.995060938714333,
a2=-0.9950718292249559
```

Note that the last line must not have a comma at the end. If the file has less than six biquads, then only that number of biquads will be imported. For example, if importing a file with four biquads, the first four filters will be set, and the last two will not be changed. (Be careful: if the last line ends with a comma, that counts as an extra biquad.)

If the file contains more than six biquads, then an error will be reported and no filters will be changed.

Crossover advanced mode

The **Crossover** blocks have eight biquads on each output channel. In **Advanced** mode, all eight biquads need to be specified. After pasting in the coefficients, click on the **Process** button for them to take effect.



6.4.3 Biquad design software

Following are programs that can be used to design your biquad coefficients.

6.4.3.1 Biquad calculation spreadsheet

The community-developed biquad calculation spreadsheet allows many filter types to be calculated, including notch filters, Linkwitz transforms, and filters with arbitrary Q-factor. Access this spreadsheet here (requires Microsoft Excel):

- http://www.minidsp.com/images/fbfiles/files/All_digital_coefs_v1-20101026.zip

6.4.3.2 Room EQ Wizard (REW)

Room EQ Wizard is a free acoustic measurement and analysis tool, available for Windows, Mac and Linux platforms. It includes the ability to automatically generate a bank of parametric EQ biquads based on a measurement. These coefficients can be saved to a file from REW and loaded directly into a PEQ bank in a miniDSP plugin. Room EQ Wizard can be downloaded here:

- <http://www.roomeqwizard.com/#downloads>

For guidance on using this feature, please refer to the app note [Auto EQ with REW](#).

6.4.3.3 Active Crossover Designer (ACD)

Active Crossover Designer (ACD) by Charlie Laub performs the complete set of functions for active crossover design and generates biquad coefficients as its output. Download it here (requires Microsoft Excel):

- <http://audio.claub.net/software/ACD/ACD.html>

6.5 WORKING WITH CONFIGURATIONS

The data that controls the audio processing is called a *configuration*. The processor stores four configuration presets in its internal memory, which can then be selected from the wired remote panel or via infrared remote.

6.5.1 Online and offline mode

Initially, the plugin is in *offline* mode. When the **Connect&Synchronize** button is used, the plugin downloads configuration data into the processor and goes into *online* mode. Changes made in the plugin user interface therefore fall into two categories:

The plugin is in online mode

The plugin user interface is “live” – that is, any changes made to the audio processing parameters in the user interface are immediately downloaded to the processor. The effect of these changes will thus be audible as the changes are made.

The plugin is in offline mode

Changes made to audio processing parameters in the plugin user interface will be made locally only. The next time the plugin is synchronized to the processor, the parameters will be downloaded to the processor (as long as the **Synchronize Config** button is selected).



The configuration contained in the miniDSP hardware unit cannot be uploaded back to the computer. Therefore, you **must** save your configuration to a file if you wish to recover from any changes you make while in offline mode.

6.5.2 Selecting a configuration

The active configuration is selected by one of the four buttons in the Configuration Selection area. By default, configuration 1 is selected:



To switch to a different configuration, click on a different button. There are two cases:

The plugin is in online mode

Audio processing will switch to the parameters contained in the selected configuration. If, however, parameters of the newly selected configuration have been changed since the last that particular configuration was synchronized to the processor, then a dialog will appear asking you if you want to synchronize the configuration.

The plugin is in offline mode

The user interface will update to show the parameters of the newly selected configuration. If this configuration is changed in the user interface, it will be downloaded to the processor the next time it is synchronized.

6.5.3 Saving and loading configurations

Configurations can be saved to and loaded from files. Each configuration is stored in a separate file. It is *very* strongly recommended that each configuration programmed into the processor be saved to a file, to ensure that the configuration is not lost if the processor is inadvertently reset.

To save the currently selected configuration to a file, drop down the File menu, then select **Save** and then **Save current configuration**. In the file box, select a location and name of the file, and save it.

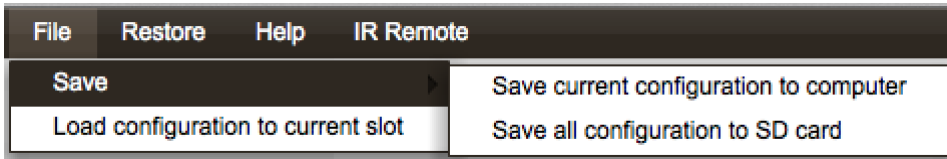

To load a configuration, first select the configuration preset that you wish to load into. Then drop down the File menu, select **Load**, and then **Load configuration to current slot**.

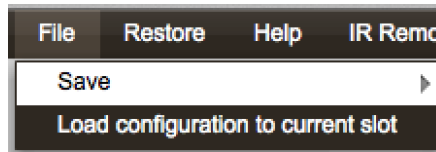

If the plugin is in online mode, the new configuration data will be downloaded to the processor immediately. If the plugin is in offline mode, the configuration will be loaded into the user interface only, and will be downloaded to the processor the next time it is synchronized.



To copy a configuration from one preset to another, save the configuration to a file, then select a different configuration preset and load the file.

6.5.4 Loading configurations from microSD card

The **C-DSP 6x8** can load a set of configurations from a microSD card. This can be used to load new configuration sets without requiring a computer connection.

1. Connect a microSD card to the computer. If the computer has an SD card slot, you can use a microSD card adapter. Or, use an external card reader connected via USB. If the card hasn't previously been formatted, format in FAT format.
2. Start the plugin. Don't connect or synchronize to the C-DSP 6x8. From the **File** menu, select **Save** and then **Save all configuration to SD card**.

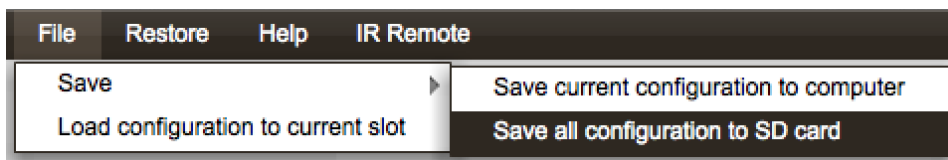

3. From the file save dialog box that opens, type in a file name, navigate to the SD card and click on Save.
4. Eject the (micro) SD card from the computer.
5. Power off the **C-DSP 6x8**. Insert the microSD card into the slot. (It pushes in and latches.) Power on the **C-DSP 6x8**.
6. The C-DSP will load all four configurations. Each button on the wired remote will light as that configuration is loaded.
7. Eject the microSD card. (Push it in gently to unlatch it, then pull it out.) The C-DSP 6x8 is ready for use with a new configuration set.

6.5.5 Restoring to defaults

Configurations can be reset to the factory defaults from the Restore menu. There are two options:

Factory Default

Reset all four configuration presets to the factory default settings.

Current Configuration Only

Reset only the currently selected configuration preset to the factory default settings.

If the plugin is in online mode, the configuration data on the processor (all or just one configuration, as selected) will also be reset to factory defaults. Otherwise, the reset will take place in the user interface only, and the new configuration data will be downloaded to the processor next time it is synchronized.

6.6 KEYBOARD SHORTCUTS

The **C-DSP 6x8** plugin supports the use of the keyboard for many operations.

Tab

The Tab key moves the focus from the current user interface element to the next. A blue-grey surrounding box usually indicates the user interface element with the focus. Shift-Tab moves the focus in the opposite direction.

Up/down arrows

The up/down arrow keys (and in some cases, the left/right arrow keys) adjust the value of many parameters, if they have the focus:

- Output channel gain
- Crossover frequency and filter type
- PEQ filter frequency, gain, and Q

Space

The Space bar toggles buttons that have two states, such as **Bypass**, **Invert**, and **Mute**, if they have the focus.

7 USING THE C-DSP 6x8

Once configuration is complete, the computer is not required and can be disconnected. The wired remote and/or an infrared remote can be used to control:

- Master volume
- Master mute
- Preset selection

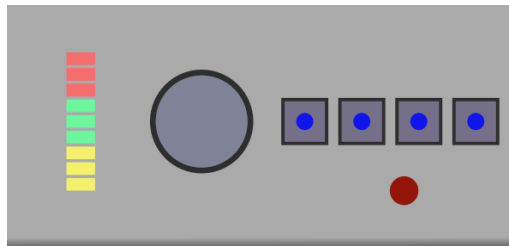

7.1 STATUS INDICATORS

The currently selected preset is indicated by a blue LED in one of the selection buttons.

7.2 CONTROLS

To change the volume

Rotate the control knob clockwise to increase the volume, and counter-clockwise to decrease it. The LED bar graph on the left indicates the master volume level setting.

To mute and unmute

Press on the control knob.

To change the preset

Press one of the four buttons. The LED of the selected preset will flash several times. When it stays lit, the selected preset is now in operation.



The preset cannot be changed from the wired remote while there is a USB connection to the computer. To change presets while connected via USB, connect via the plugin and use the Config selectors.

7.3 SUBWOOFER VOLUME CONTROL MODE

By default, the volume knob adjusts the master volume – that is, the level of all output channels. The C-DSP 6x8 can be set to control just one or two output channels, which is typically used to adjust subwoofer volume. That is, the volume control modes are:

- Master volume (all output channels)
- Channel 8 only
- Channels 7 and 8 only

!! This requires C-DSP 6x8 plugin version X or later and firmware version Y or later. If you have an earlier version, please upgrade the plugin and firmware before doing this.

To change the volume mode:

1. Press Preset 1 and Preset 2 buttons at the same time, then release.
2. Both Preset 1 and Preset 2 LEDs will light up or blink.
3. Press the Preset 4 button to cycle through the three volume control modes. The Preset 1 and Preset 2 LEDs will display as shown in Table 1.
4. After selecting the desired mode, press Preset 1 and Preset 2 buttons at the same time, then release. A single LED will light to indicate the currently selected preset.

Table 1. Volume control mode selection

Volume control mode	Preset LED 1	Preset LED 2
Master volume	Light up	Light up
Channel 8 only	Blinking	Light up
Channels 7 and 8 only	Light up	Blinking

7.4 INFRARED REMOTE CONTROL

Many standard and programmable remote control units can be used with the C-DSP 6x8. Rather than make you acquire yet another remote, the C-DSP 6x8 can “learn” the control codes of your current remote if it supports one of the following remote control codes:

- NEC
- Sony
- Philips RC6

To initiate the learning process, drop down the IR Remote menu and select **IR learning**. Click on the **Learn** button for an operation, and then press the desired button on the remote control. If the code is accepted, the status will change to show a tick.

This screenshot shows the IR learning screen:

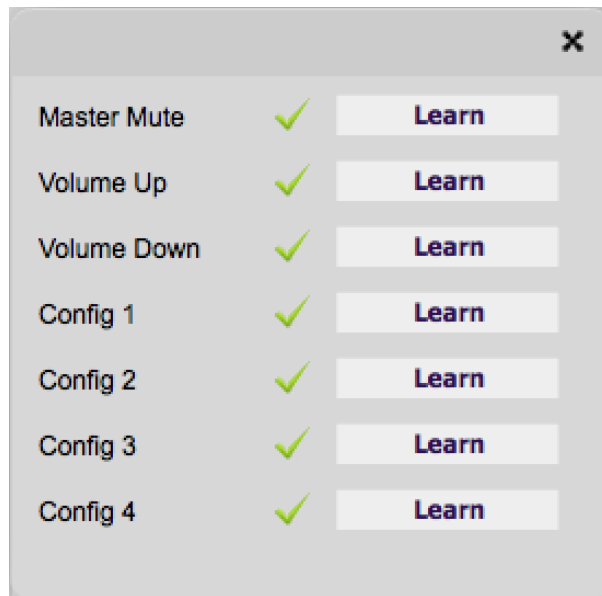

To "unlearn" a command, press the **Learn** button and wait for the plugin to time out.



The preset cannot be changed with the infrared remote while there is a USB connection to the computer. To change presets while connected via USB, connect via the plugin and use the Config selectors.

8 ADDITIONAL INFORMATION

8.1 SPECIFICATIONS

Computer connectivity	Driverless USB 2.0 control interface for Windows and Mac OS X
Analog audio inputs	4 x high level (Terminal Block), Max 8 Vrms 4 x low level unbalanced (RCA) inputs, Max 4 Vrms
Digital audio Input	S/PDIF on RCA connector / Isolated with digital audio transformer A high quality onboard Asynchronous Sample Rate Converter ensures compatibility with most sample rates, from 44.1 up to 192 kHz.
Analog audio outputs	8 x outputs on unbalanced (RCA) connectors, 2.0V RMS full scale output
Audio resolution	24-bit input and output, 48 kHz internal sample rate
Audio processing	172MHz, 28/56bit Digital Signal Processor
Storage/presets	All settings controllable in real time from software user interface. Up to 4 presets stored in local flash memory.
Wired external remote	External remote for control of active preset, master volume and master mute. LED indication of master volume and active Preset. Provides power and data connection to the external remote via RJ11 cable.
microSD Card	Allows setup without a laptop: a configuration can be built offline and loaded automatically to the unit in the car via a microSD Card.
Infrared remote	“Learning remote” capabilities (NEC, Philips, Sony) Controls master volume, mute, preset selection.
Power supply	Isolated DC-DC conversion for Car Audio environment
Dimensions (H x W x D)	41 x 205 x 122 mm

8.2 TROUBLESHOOTING

The following table lists the most common causes of issues. If following this table does not provide a solution, see [Obtaining Support](#) below.

Item#	Symptoms	Troubleshooting recommendation
1	Cannot install software	a. Confirm that you downloaded and installed the required frameworks first (see Software Installation).
2	Software running in background but not showing	a. The Adobe Air environment may need a network connection the first time you run a plugin. Close the plugin program, ensure that your computer has a network connection, and restart the plugin. b. The Adobe Air environment may require a version update. Download the latest version from http://get.adobe.com/air/ .
3	Cannot connect to the board by USB	a. Reset the processor by power-cycling the unit. b. Make sure the processor is seen in the device manager as a HID device.
4	No audio or low audio on outputs	a. Check the cabling from the processor to your amplifiers. b. Check that your amplifiers are turned on and that any volume controls are turned up. c. Check that the input meters and output meters are showing adequate signal (if not, see item 5). d. Check that master mute is not enabled. e. Check that the mute buttons in the output control blocks are not enabled. f. Check that your crossover frequencies are correct e.g. that you don't have high pass and low pass frequencies incorrectly set. g. Check that the matrix mixer is sending the correct inputs to the correct outputs.
5	No signal showing on input meters	a. Check the cabling from your source/s. b. Check that your source is playing audio and that it is not muted or have volume control turned down. c. Check that the plugin is synchronized with the hardware unit.
6	Audio sounds distorted	a. Check the input meters and ensure that you are not overloading the inputs. If necessary, reduce the signal level from the source or change the input sensitivity jumpers. b. Check the output meter and ensure that you are not overloading the outputs. If necessary, reduce the output gain

		and/or the amount of boost in the EQ blocks.
6	Audio is coming through the wrong outputs	<ol style="list-style-type: none"> a. Check the cabling from the processor to your amplifiers. b. Check the cabling from your source/s. c. Check that you have correctly set up the matrix mixer to send the correct inputs to the correct outputs.
7	Cannot reload a configuration	<ol style="list-style-type: none"> a. Confirm the file format of your file (.xml). b. Confirm the version of the file.

8.3 OBTAINING SUPPORT

1. Check the forums on minidsp.com to see if this issue has already been raised and a solution provided.
2. Contact miniDSP via the support portal at minidsp.desk.com with:
 - a. The specific product you are having an issue with (in this case, C-DSP 6x8).
 - b. A clear explanation of the symptoms you are seeing.
 - c. A description of troubleshooting steps (see [Troubleshooting](#) above) performed and your results.